

**NSK**  
CREATE IT.

The all-new

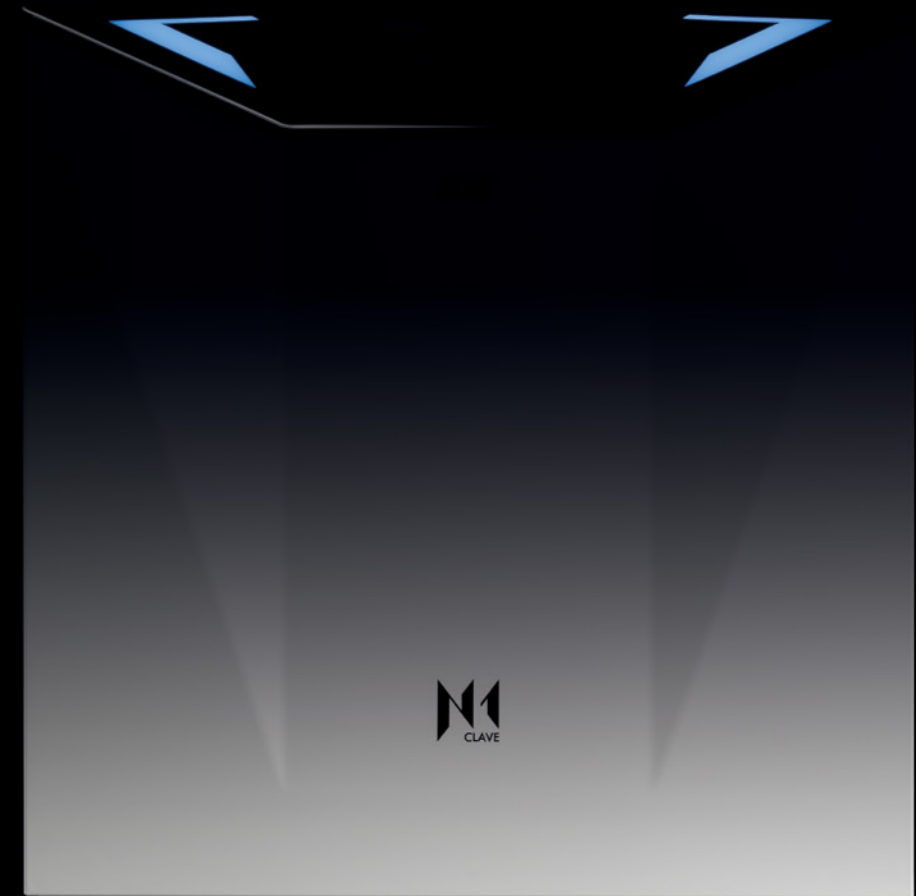

**NSK**



## If the future were an autoclave...

High performance, cutting-edge technology that interacts with humans and respect for the environment.  
With its **6 registered patents**, N1clave was created to give innovative answers to today's challenges and the needs of professionals and their teams.  
A revolutionary concept in 5 versions: an unprecedented load-time ratio in the sterilization cycle, advanced connectivity and user experience and operation using just tap water, which you can either reuse at the end of the cycle or drain without contaminating the environment.

...it would be N1clave.







A leap forward that changes our habits, everyday gestures and even what we ask from technology. That's when the revolution happens. **Performance, technology, sustainability:** whatever the keyword of your idea of the future, N1clave will help you shape it.

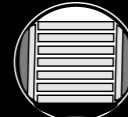
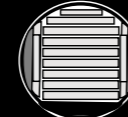

**Time is the most precious resource**, both at work and in our private lives. This is the reason why N1clave ensures superior performance, thanks to patented innovative technologies, which increase the cycle speed and dry the instruments perfectly. Its extraordinary efficiency is perfectly expressed in the ratio between the load capacity of its chamber and the time required to complete a cycle: this ratio allows to see at a glance the difference in performance between N1clave and other autoclaves. For example, N1clave 8 30 can sterilise an 8 kg load in just 30 minutes (a performance index of 3.75 minutes per kilo) with reduced power consumption. No other autoclave on the market claims to match this performance.

640	750	830	940	1050
11"	11"	11"	11"	11"
				
6 trays 290 mm long	6 trays 370 mm long	7 trays 290 mm long	7 trays 370 mm long	9 trays 370 mm long
6 kg 40 min	7 kg 50 min	8 kg 30 min	9 kg 40 min	10 kg 50 min

Time measured for B cycle Universal 134 with solid load, single wrapped.



# Time

performance



1050

N1clave owes its spectacular performance to a combination of innovative technologies.

The **Boosteam™** system (which combines the booster with the steam generator inside the chamber) speeds up the sterilization cycle while optimising the chamber load.

The **Zeodry™** system uses zeolite, a mineral that absorbs moisture and releases heat, thereby improving drying performance while reducing energy consumption.

The **11" diameter chamber** and the innovative modular trays system allow to comfortably manage the large loads that the autoclave is able to sterilize. Higher speed, greater load, higher savings and more safety: for this reason, N1clave does not make a generic promise in litres capacity (18 l, 24 l, 28 l) but speaks in practice of kilos of load in relation to the minutes necessary to sterilize it.

1

### Boosteam™



A simple and ingenious idea: placing two boosters and the steam generator inside the chamber, respectively on the two sides and on the bottom. In this way, N1clave guarantees maximum performance using space that is usually empty and wasted.

2

### Zeodry™

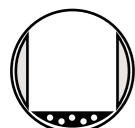

The zeolite is a self-regenerating material, which does not need maintenance or to be periodically replaced: contained within the steam generator, it contributes to the maximum performance of N1clave.

3

### 11" chamber

The extraordinary performance of N1clave finds its first and fundamental condition in the 11" diameter chamber, in two different depths, which characterizes all the autoclave versions.

The chamber guarantees a large and optimized load volume, also thanks to the innovative modular system of trays and the possibility of inserting sterilization cassettes and containers of various types and models.

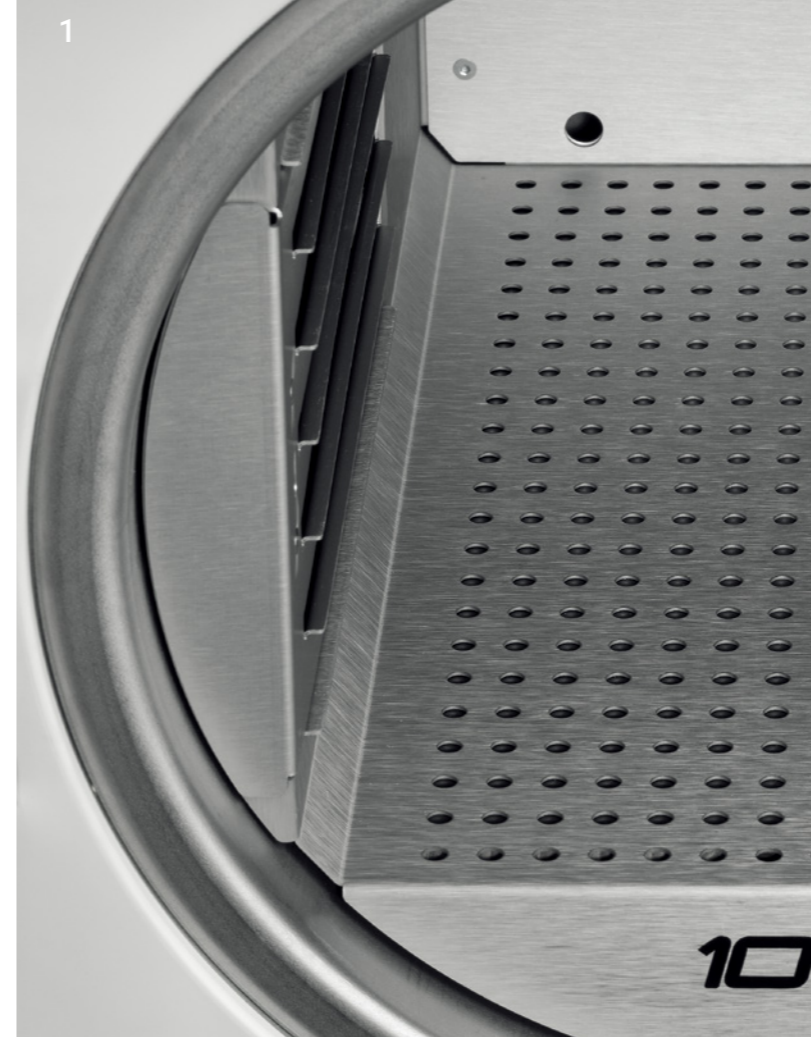

A simple touch is all you need to connect to the future of sterilization. N1clave is the first autoclave that is perfectly in sync with contemporary languages and meets the need to manage each operation and stage in a precise, intuitive and comfortable way. The latest generation connectivity allows you to manage the data of the sterilization cycles securely and receive precise and timely assistance, the innovative Light Signature accompanies every step and warns about any risk, the elegant and immediate graphic interface allows to use the menus in a simple and innovative way.

# Touch technology



Technology is getting more and more advanced, people have less and less time. The innovation of N1clave nullifies this gap with an extremely gratifying user-experience in its being effective and immediate. This is the deep reason in choosing the light, a primordial and evolved element at the same time, as a fundamental communication tool and a distinctive aesthetic feature of N1clave. The **Light Signature** system indicates the status and the work stage of N1clave through a series of colours and signals (blinking, pulsed, and fixed lights). The **touch screen**, placed in an optimal position, completes a user-experience that is at the same time advanced and intuitive in every aspect – revolutionary for an autoclave.

## 1

### Light Signature

The combination of colours and light signals makes it extremely easy, safe and pleasant to follow N1clave in all its work phases.

LIGHT TYPE	MEANING	BLUE	YELLOW	RED	GREEN
BLINK	attention	switching on	warning	alarm	-
IMPULSE	in progress	heating	-	-	dry start/cycle to end
FIX	running	cycle process	manual stop in dry	-	cycle end ok

## 2

### Touch screen

Positioned at the center of the innovative cockpit and characterized by the ergonomic inclination, the touch screen offers an extremely gratifying work experience.

1



2





Efficiency, control, safety. N1clave innovative **Web Client** puts the most advanced connectivity for the first time in the service of sterilization, with packages of varying services never seen in this field. These services are collected and made available in two different ways: Dashboard and Cloud.

Thanks to the **Dashboard** services of the innovative Web Client, you can control the autoclave remotely (checking its status: if it is switched on, working, blocked, and so on), receive communications and alerts, be informed of the need to carry out ordinary and extraordinary maintenance operations.

With the **Cloud** services, it is possible to track and store all the data of the cycles in a completely safe way, download them and make them available in a PDF or in digitally signed format, identified by a distinctive serial number, which can not be in any way counterfeited.

The extraordinary user-experience of N1clave meets a fundamental requirement: to create a digital environment of signals and icons that naturally accompany every gesture of the operator through a simple and linear sequence of steps, making her work serene and precise in such a delicate operation as instrument sterilization.

The **graphic interface** of the touch screen menu responds exactly to these needs: clarity, immediacy, precision in the management of cycles, tests and any other operation, ordinary and extraordinary.

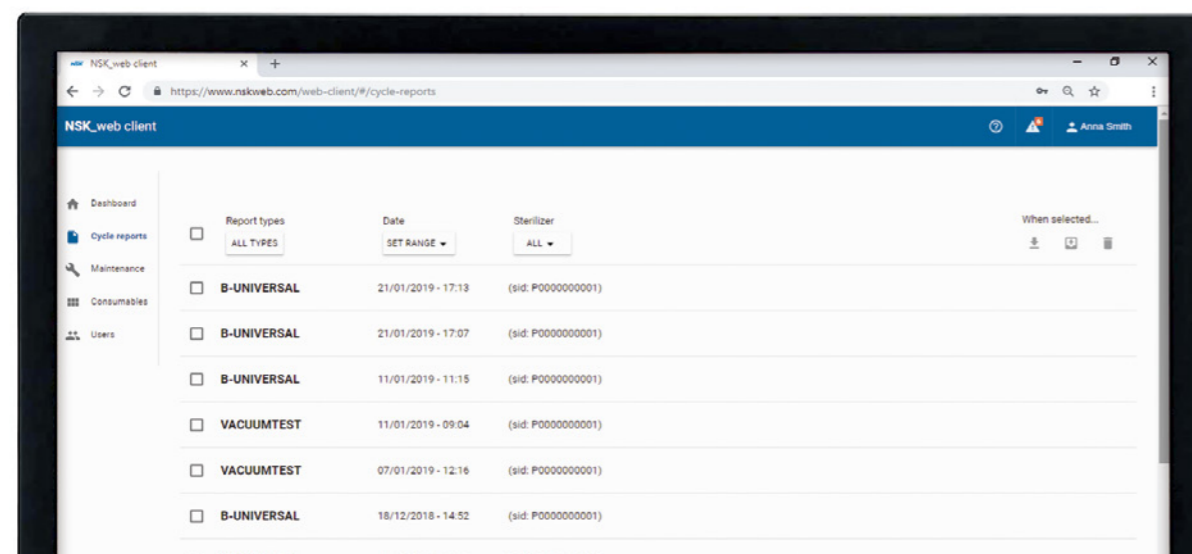
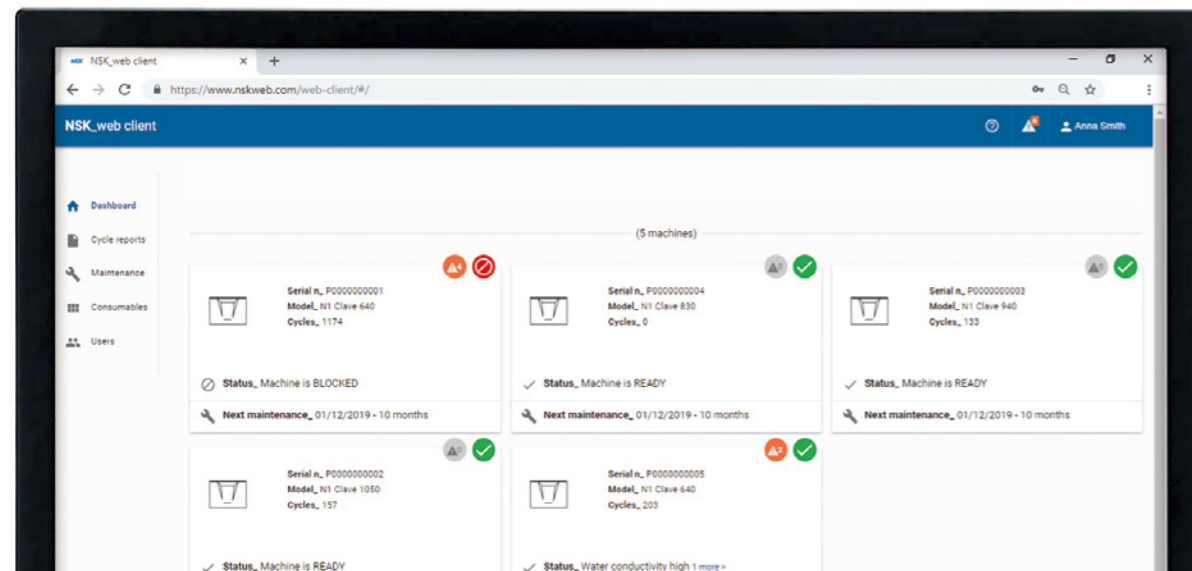

CYCLE SELECTION

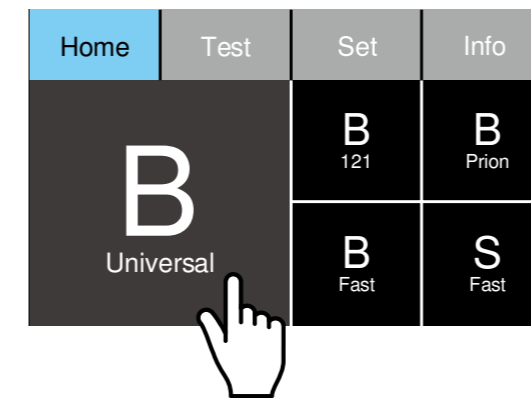

GENERAL SETTINGS

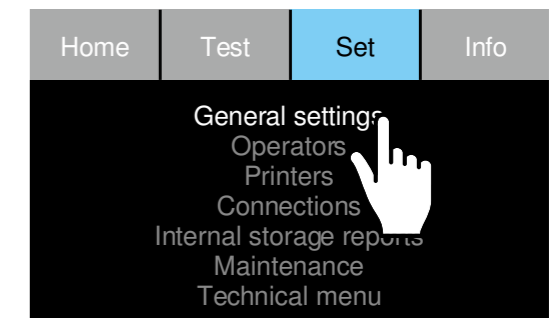

CYCLE START

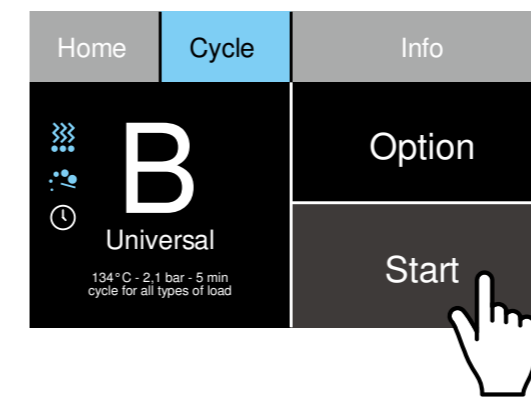

SETTING SELECTION

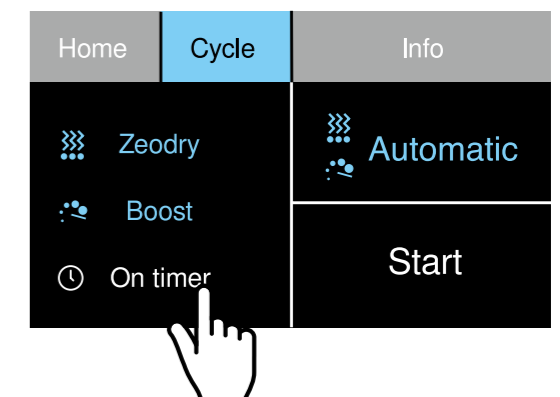

CYCLE IN PROGRESS

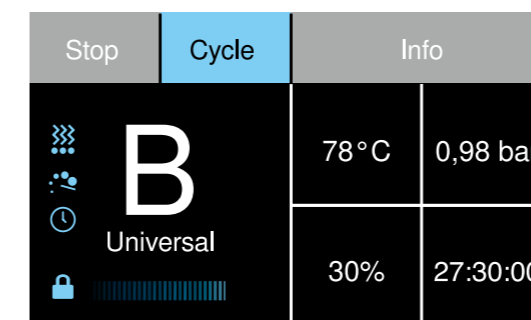

WARNINGS

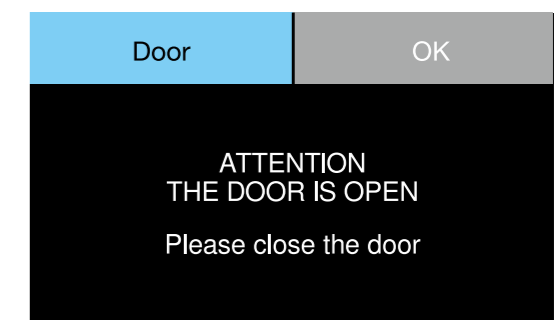

**N1clave is the first autoclave that works with tap water.**

That alone tells you how revolutionary it is. But there is more. An extraordinary innovation, due to the Water Perpetual™ system, with its special patented filters positioned inside the autoclave. In this way, N1clave increases comfort in sterilization management and takes care of the environment and a precious resource such as water. For environmental sustainability in technology is today's true innovation.



Simply open the tap, fill a jug with water and pour into the new N1clave. The **Water Perpetual™** system, through the **Water-In Filters**, makes the water quality suitable for the sterilization cycle. Furthermore, it guarantees a potentially infinite recycling of water, which when filtered at the end of the sterilization cycle through the **Water-Out Filter** can be reused or released already decontaminated into the environment. An extremely easy and safe choice, which you make by operating the easily accessible selector positioned on the front of the autoclave.

With N1clave, the environment is respected and no distilled water is needed. There is no need for external, uncomfortable, cumbersome and expensive filtering devices. Eco-sustainability and safety, thanks to the visualization in the graphic interface of the **water quality** and the status of the filters and to the yellow highlighting of the parts of the filtering system on which to intervene for maintenance.



**1**  
**Water Perpetual™**



The control panel of the Water Perpetual™ system, located on the front of the autoclave, includes the water drain tap, the selector for the activation of water recycling and the outlet tap.

**Water-Out Filter**

The Water-Out Filter is positioned so as to be easily accessible.

**2**  
**Water-In Filters**

The Water-In Filters are housed in the tank unit, easily reachable by lifting the cover and replacing it effortlessly and with maximum ease.

**3**  
**Water quality**

The innovative graphic interface allows you to monitor the quality of the water and its evolution.



**Autoclave versions** A single, revolutionary concept, available in 5 versions that differ in terms of load capacity, number of trays in the 11" chamber and time required for the sterilization cycles.

With N1clave, you always step into the future of sterilization. Thanks to its 5 versions you can choose how to do it: based on the specific needs of each clinic.



	640	750
CHAMBER DIMENSIONS	11" x 350 mm	11" x 450 mm
LOAD CAPACITY (MAX)	6 kg	7 kg
TRAYS	6 trays 212 x 290 mm	6 trays 212 x 370 mm
CYCLE TOTAL TIMING PERFORMANCE* (DRYING INCLUDED)	40 min	50 min
COCKPIT COLOUR	glossy white	glossy white
LIGHT SIGNATURE	-	-
WATER PERPETUAL™	✓	✓
STEAM GENERATOR	✓	✓
ZEOLITE	-	-
BOOSTERS + COOLING	-	-
USB	✓	✓
LAN	✓	✓
WEB CLIENT**	✓	✓



	830	940	1050
CHAMBER DIMENSIONS	11" x 350 mm	11" x 450 mm	11" x 450 mm
LOAD CAPACITY (MAX)	8 kg	9 kg	10 kg
TRAYS	7 trays 212 x 290 mm	7 trays 212 x 370 mm	7 trays 212 x 370 mm 1 tray 194 x 370 mm 1 tray 147 x 370 mm
CYCLE TOTAL TIMING PERFORMANCE* (DRYING INCLUDED)	30 min	40 min	50 min
COCKPIT COLOUR	glossy black	glossy black	glossy black
LIGHT SIGNATURE	✓	✓	✓
WATER PERPETUAL™	✓	✓	✓
STEAM GENERATOR	✓	✓	✓
ZEOLITE	✓	✓	✓
BOOSTERS + COOLING	✓	✓	✓
USB	✓	✓	✓
LAN	✓	✓	✓
WEB CLIENT**	✓	✓	✓

\* approx. time measured for B cycle Universal 134 with solid load, single wrapped.

\*\* terms and conditions may vary from country to country.

**Sterilization cycles** N1clave guarantees sterilization cycles fully compliant with international regulations, offering unrivaled performance in terms of load-time ratio, in total safety.

PROGRAM	WRAPPING	ESPECIALLY SUITABLE FOR	STERILIZATION FOR	640	750	830	940	1050	
<b>B</b> Universal	Single and multiple wrapped	Mixed loads; long, narrow bore hollow bodies	134 °C Sterilization time 5,5 min	OPERATING TIME*	30-40 min	40-50 min	20-30 min	30-40 min	40-50 min
				DRYING	10 min	10 min	10 min	10 min	10 min
				LOAD (MAX)	6 kg	7 kg	8 kg	9 kg	10 kg
<b>B</b> 121	Single and multiple wrapped	Mixed loads; larger quantities of textiles; thermo-instable goods (e.g. plastic, rubber goods)	121 °C Sterilization time 20,5 min	OPERATING TIME*	42-52 min	52-62 min	32-42 min	42-52 min	52-62 min
				DRYING	15 min	15 min	15 min	15 min	15 min
				LOAD (MAX)	6 kg	7 kg	8 kg	9 kg	10 kg
				LOAD TEXTILE (MAX)	1,5 kg	2 kg	2,5 kg	3 kg	3,5 kg
<b>B</b> Prion	Single and multiple wrapped	Instruments where a danger of infection by pathologically modified proteins is suspected (e.g. Creutzfeld-Jacob-Disease, BSE)	134 °C Sterilization time 20,5 min	OPERATING TIME*	45-55 min	55-65 min	35-45 min	45-55 min	55-65 min
				DRYING	15 min	15 min	15 min	15 min	15 min
				LOAD (MAX)	6 kg	7 kg	8 kg	9 kg	10 kg
				LOAD TEXTILE (MAX)	1,5 kg	2 kg	2,5 kg	3 kg	3,5 kg
<b>B</b> Fast	Single wrapped and unwrapped instruments (no textiles)	Narrow bore hollow bodied instruments	134 °C Sterilization time 3,5 min	OPERATING TIME*	20-25 min	25-30 min	15-20 min	25-30 min	28-32 min
				DRYING	6 min	6 min	6 min	6 min	6 min
				LOAD (MAX)	1 kg	1,2 kg	2 kg	2,5 kg	3 kg
<b>S</b> Fast	Only unwrapped (no textiles)	Simple solid instruments; transmission instruments; simple hollow bodies	134 °C Sterilization time 3,5 min	OPERATING TIME*	15-20 min	20-25 min	13-18 min	18-23 min	20-25 min
				DRYING	4 min	4 min	4 min	4 min	4 min
				LOAD (MAX)	1 kg	1,2 kg	2 kg	2,5 kg	3 kg

**AUXILIARY PROGRAM**



VACUUM TEST  
BOWIE & DICK TEST

**USE/FUNCTION**

For measuring leak rate, a test for dry and cold device (test without load)  
Steam penetration test with special test package

\* The cycle operating time is variable and depends on the load and the installation conditions.

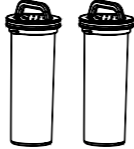
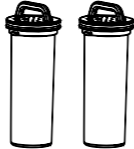
**Water treatment** N1clave simplifies and makes water treatment even safer, thanks to the two long-life internal filters – the first and only autoclave with this kind of feature. N1clave always offers excellent performance, even when the level of conductivity of the water is not optimal: in this case, it is sufficient to simply equip the autoclave with a third additional filter, that can be easily placed in its specific slot.

WATER QUALITY (µS)	LITRES	CYCLES	WATER-IN FILTERS
0-200	300	600	
200-400	200	400	
400-600	150	300	

Water-In Filters suggested configuration and available cycles, based on tap water conductivity of the clinic.

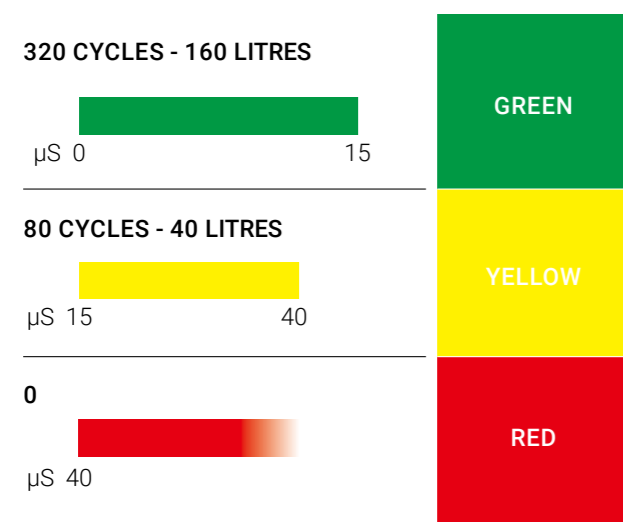

Average performance in case of tap water conductivity 200 µS > 400 µS.

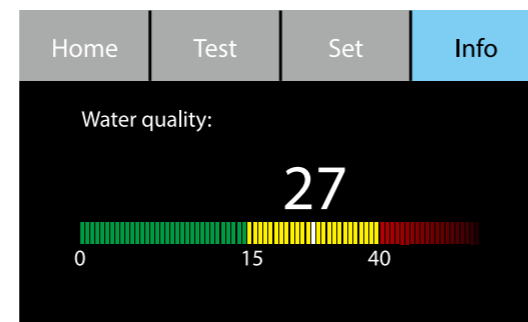

Example of water quality visualization and monitoring in the graphic interface.

### Accessories

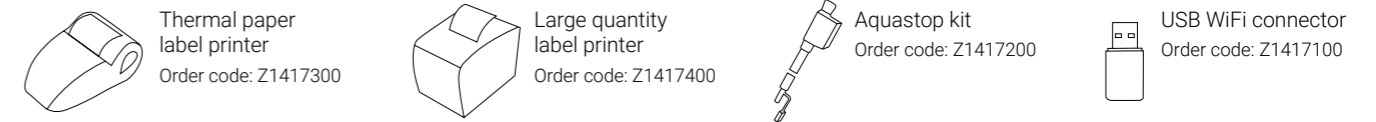

### Technical datasheet

#### OVERALL REQUIRED SPACE

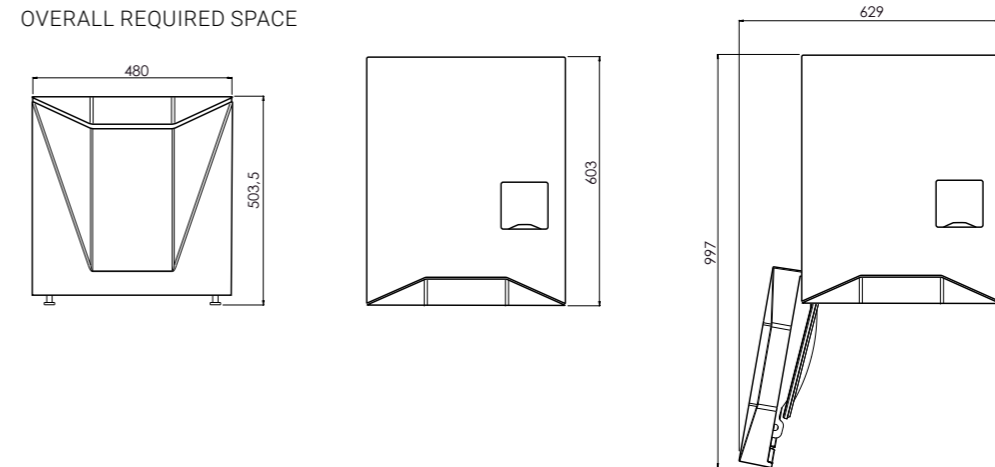

#### USEFUL SPACE

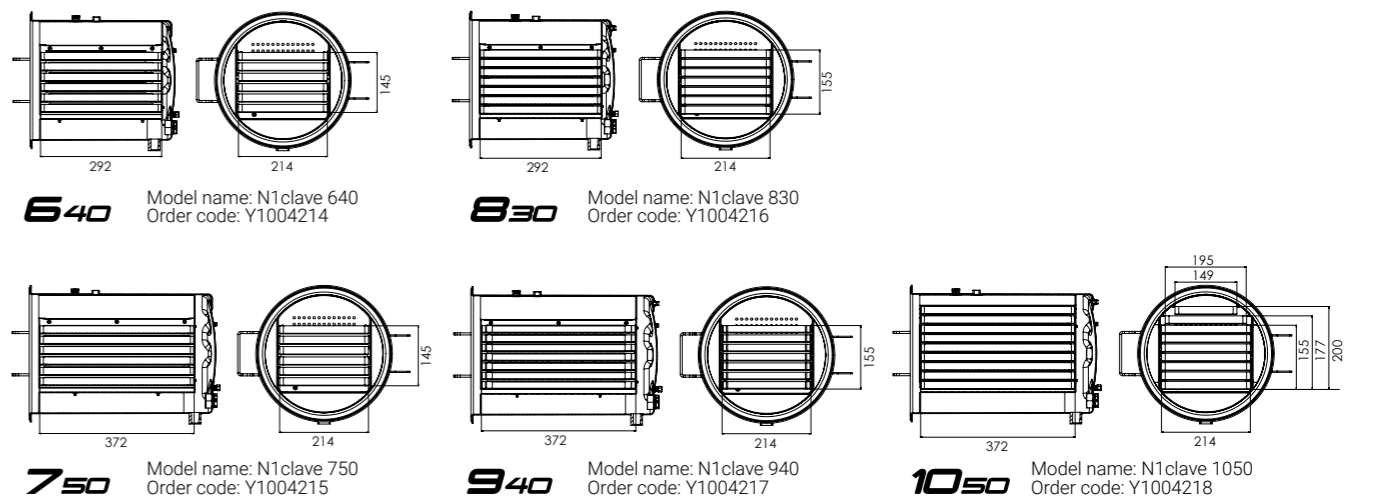

### Documentation

- Device declaration of conformity
- Chamber declaration of conformity
- Operating manual
- Quick start guide
- Work test report

### Main compliance with harmonised standards

- EN 13060
- EN ISO 14971
- EN ISO 13485
- EN 61010-1
- EN 61010-2-040
- EN 61326-1
- EN 13445
- EN 62304

### Certification information

- Medical device directive (MDD): 93/42/EEC
- Classe II B device
- Chamber compliance to PED directive 97/23/EEC
- ISO 9001

This catalogue cannot be copied, scanned or reproduced by any means. All rights reserved to NAKANISHI INC. NAKANISHI INC. registered trade-marks: N1clave®, Water Perpetual™, Boosteam™, Zeodry™, cannot be reproduced by any means, neither used by anyway. Pictures, description, quoting, dimension and technical data in this catalogue have to be considered as purely indicative. While maintaining the basic characteristics of the product, the manufacturer reserves the right to make modifications any time with the sole aim of improvement.